



Project: _____
 Location: _____
 Cat. #: _____
 Type: _____
 Quantity: _____



FFR G2 22 | LED Lay-In Retrofit Kit

Features:

- High performance LED technology
- 90+ CRI standard
- 0-10V dimming drivers standard
- Field replaceable LED boards and drivers
- Frosted diffuser optimized to balance efficiency and aesthetics
- Available in a wide variety of lumen outputs for maximum flexibility
- Quick and easy installation helps save on labor costs
- Advanced controls available
- Buy American Act compliant *(All base luminaires are BAA compliant. Addition of options may change eligibility. Contact factory for details.)*

Applications:

Suitable for most commercial and institutional applications

- Office
- Retail
- Classrooms
- Healthcare Facilities

Predicted Lifetime:

- L70: 129,000 hrs (calculated)
 - L80: 81,000 hrs (calculated)
 - L90: 39,000 hrs (reported)
 - 85% lumen maintenance @ 60,000 hrs
- (based on LM80 and insitu laboratory testing)*

Construction:

- Die-formed heavy-gauge cold rolled steel ballast housing with precision brake formed aluminum LED tray
- Frosted Acrylic Diffuser
- White enamel finish

Certifications:

- UL 1598 listed for US and Canada, suitable for damp locations
- DesignLights Consortium qualified on specific configurations (refer to DLC qualified products list for exact model numbers) <http://designlights.org/>



Warranty:

- 5 year limited system warranty - see www.LumenFocus.com for complete warranty terms and conditions
 - 10 year warranty option available on specific models
- (Not available on all models. Certain conditions apply. Consult factory or sales representative for details.)*



Ordering Guide:

example: FFR G2 22 MD UV FA 935 EM10

Series	Size	Output	Voltage	Shielding	CRI/CCT	Controls ⁽¹⁾	Options		
FFR G2	22			FA					
FFR G2 FFR Gen 2	22 2' x 2'	SL Super Low	UV 120-277	FA Frosted Acrylic	930 90 CRI/3000K	Blank No Controls	Blank No Options		
		VL Very Low	34 347V		935 90 CRI/3500K			ZSOL Leviton Programmable 0-10V dimming Occupancy Sensor with Daylight Harvesting, Task Tuning	EXT10 10-Year Extended Warranty ⁽²⁾
		LW Low			940 90 CRI/4000K			ZSLFC2 Keystone SmartLoop Bluetooth-enabled Programmable 0-10V Dimming Occupancy Sensor with Daylight Harvesting, Task Tuning, Grouping, Scheduling	SD Step Dimming
		MD Medium			950 90 CRI/5000K			ZESMC Philips EasySense Bluetooth-enabled Programmable DALI Dimming Occupancy Sensor with Daylight Harvesting, Task Tuning, Grouping, Scheduling	EM6 6.5W Emergency Pack ⁽³⁾
		HI High						ZL7S Leviton Intellect Bluetooth-enabled Programmable 0-10V Dimming Occupancy Sensor with Daylight Harvesting, Task Tuning, Grouping, Scheduling, Networking Capabilities	EM10 10W Emergency Pack ⁽³⁾

Notes

- ⁽¹⁾ See 'Control Summary' on Page 4 for more details.
- ⁽²⁾ Not available on all models. Certain conditions apply. Consult factory or sales representative for details.
- ⁽³⁾ 120-277V / 0°C-55°C ambient. To estimate lumen output in emergency mode, multiply EM wattage by the Lumens per Watt of the luminaire it is installed in.
ex. FFR G2 22 MD UV FA 940 EM10 → 142.2 LPW x 10W = 1,422 lm

LUMENFOCUS
Re-boardABILITY

The FFR features field replaceable boards and drivers. This allows you to upgrade to more efficient technology in the future. Or, in the rare event of a failure, you can rapidly replace defective components. Re-boardABILITY helps to ensure you won't get stuck with an obsolete light fixture. [Learn more about Re-boardABILITY here.](#)

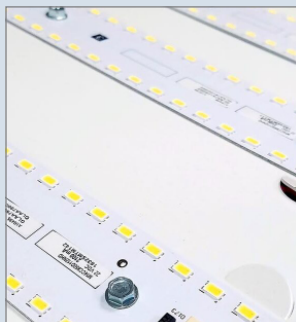

[Click here for a video demonstration of the re-boarding process on a FFR.](#)
Note: Exact time varies depending on the model.

- ZL7C
Leviton Intellect Bluetooth-enabled Programmable 0-10V fixture controller with Task Tuning, Grouping, Scheduling, Networking Capabilities
- ZLDS
Leviton Intellect Bluetooth-enabled Programmable DALI Dimming Occupancy Sensor with Daylight Harvesting, Task Tuning, Grouping, Scheduling, Networking Capabilities
- ZLDC
Leviton Intellect Bluetooth-enabled Programmable DALI fixture controller with Task Tuning, Grouping, Scheduling, Networking Capabilities
- ZLTS
LiteTrace Bluetooth-enabled Programmable 0-10V Dimming Occupancy Sensor with Daylight Harvesting, Task Tuning, Grouping, Scheduling, Advanced Networking & IoT Capabilities
- ZLTC
LiteTrace Bluetooth-enabled Programmable 0-10V fixture controller with Task Tuning, Grouping, Scheduling, Advanced Networking & IoT Capabilities

- F
Fuse
- SM
Easy Access Side Mounted Driver
- AR
Plenum Ceiling Air Return
- LVL
0-10V Dimming Leads for Easy Field Access
- BAA
Buy American Act Compliant

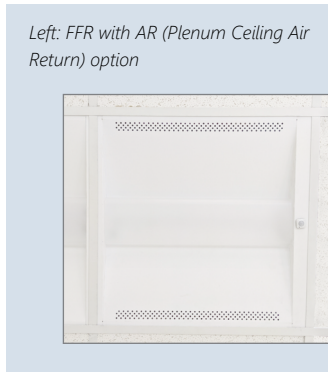

Controls Accessories (order separately)

Accessory Code	Description	Control Compatibility	Additional Info
ZLSOR-RA1	Wireless IR Configuration Tool	ZSOL	pg. 4
KTSL-WS1-B-SG/G2	5-Button Bluetooth Wireless Wall Switch (battery powered)	ZSLFC2	pg. 4
KTSL-TK1-USB	USB Time Keeper	ZSLFC2	pg. 4
ZBT-S1AWH	Single Rocker ZigBee Wireless Wall Switch (self powered)	ZESMC	pg. 5
ZBT-S2AWH	Dual Rocker ZigBee Wireless Wall Switch (self powered)	ZESMC	pg. 5
SWS200	Philips Zigbee Green Power 4-Button Wall Switch (battery powered)	ZESMC	pg. 5
DRKDN-U1W	1-Button Wireless Wall Controller (line voltage powered)	ZL7S, ZL7C, ZLDS, ZLDC	pg. 5
DRKDN-U2W	2-Button Wireless Wall Controller (line voltage powered)	ZL7S, ZL7C, ZLDS, ZLDC	pg. 5
DRKDN-U4W	4-Button Wireless Wall Controller (line voltage powered)	ZL7S, ZL7C, ZLDS, ZLDC	pg. 5
DRKDN-U8W	8-Button Wireless Wall Controller (line voltage powered)	ZL7S, ZL7C, ZLDS, ZLDC	pg. 5
WP1013	3-Button Bluetooth Wireless Wall Switch (battery powered)	ZLTS, ZLTC	pg. 6
WP1025	5-Button Bluetooth Wireless Wall Switch (battery powered)	ZLTS, ZLTC	pg. 6
WP1018	8-Button Bluetooth Wireless Wall Switch (battery powered)	ZLTS, ZLTC	pg. 6
WP1018A	8-Button Bluetooth Wireless Wall Switch (battery powered)	ZLTS, ZLTC	pg. 6
WP10135S	3-Button Bluetooth Wireless Wall Switch (line voltage)	ZLTS, ZLTC	pg. 6
WP1017S	7-Button Bluetooth Wireless Wall Switch (line voltage)	ZLTS, ZLTC	pg. 6
IWS102	Bluetooth Wireless Wall Switch w/ PIR Sensor (line voltage)	ZLTC	pg. 6

Photometric Data:

FFR G2 22 HI UV FA 950

Test No.: LLIA001588-014

Luminaire Lumens: 5,902.1 lm

Luminaire Watts: 43.8W

Efficacy: 134.9 LPW

Spacing Criterion (0-180): 1.20

Spacing Criterion (90-270): 1.28

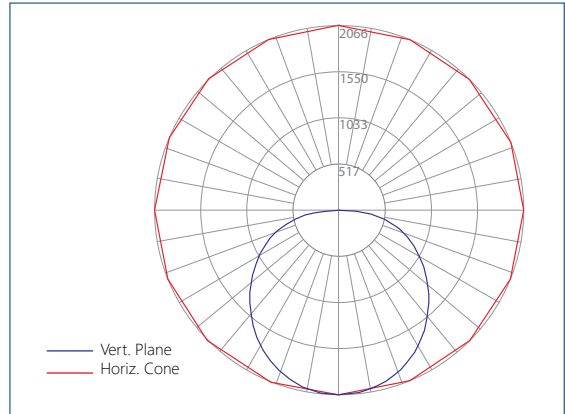

Performance Chart:

Catalog #	Watts	Lumens (930)	LPW (930)	Lumens (935)	LPW (935)	Lumens (940)	LPW (940)	Lumens (950)	LPW (950)
FFR G2 22 SL UV FA xxx	14.4	1870.0	129.7	1877.8	130.2	1922.4	133.3	1922.4	133.3
FFR G2 22 VL UV FA xxx	21.6	2834.8	131.3	2846.8	131.8	2914.4	134.9	2914.4	134.9
FFR G2 22 LW UV FA xxx	28.5	3823.7	134.0	3839.9	134.6	3931.1	137.8	3931.1	137.8
FFR G2 22 MD UV FA xxx	34.2	4728.7	138.3	4748.6	138.9	4861.4	142.2	4861.4	142.2
FFR G2 22 HI UV FA xxx	43.8	5740.9	131.2	5765.1	131.8	5902.1	134.9	5902.1	134.9

Schematic:

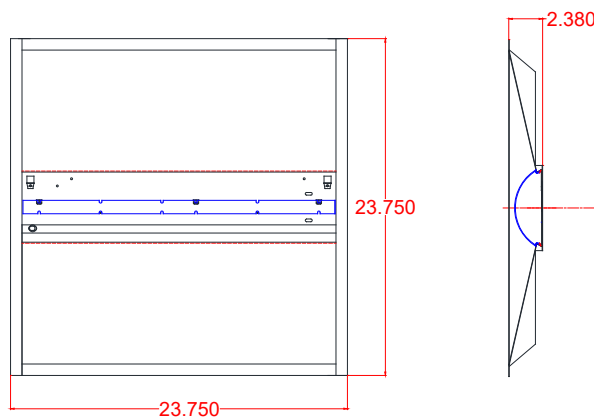

Controls Summary:

Control Code	Occupancy	Daylight	Tech	Voltage	Dim	Max Mounting Ht.	Networking	Scheduling	BMS Integration	User Interface	Add. Info
ZSOL	High/Low/Off	Daylight Harvesting	PIR	12-24VDC	0-10V	10'	N/A	X	X	On Device, IR Remote*	pg. 4
ZSLFC2	High/Low/Off	Daylight Harvesting	PIR	10-15VDC	0-10V	16'	Bluetooth Mesh	✓	X	iOS / Android App, Wireless Wall Switch*	pg. 4
ZESMC	High/Low/Off	Daylight Harvesting	PIR	DALI-2 (120-277V)	DALI	10'	ZigBee 2.4GHz Mesh	✓	X	iOS / Android App, Wireless Wall Switch*	pg. 5
ZL7S	High/Low/Off	Daylight Harvesting	PIR	12-24VDC	0-10V	20'	ZigBee 2.4GHz Mesh	✓	✓	iOS / Android App, Wireless Wall Switch (required)*	pg. 5
ZL7C	N/A	N/A	N/A	12-24VDC	0-10V	N/A	ZigBee 2.4GHz Mesh	✓	✓	iOS / Android App, Wireless Wall Switch (required)*	pg. 5
ZLDS	High/Low/Off	Daylight Harvesting	PIR	DALI-2 (120-277V)	DALI	20'	ZigBee 2.4GHz Mesh	✓	✓	iOS / Android App, Wireless Wall Switch (required)*	pg. 5
ZLDC	N/A	N/A	N/A	DALI-2 (120-277V)	DALI	N/A	ZigBee 2.4GHz Mesh	✓	✓	iOS / Android App, Wireless Wall Switch (required)*	pg. 5
ZLTS	High/Low/Off	Daylight Harvesting	PIR	120-277V	0-10V	18'	Bluetooth LE Mesh	✓	✓	iOS / Android App, Wireless Wall Switch*, Autani Web Interface*	pg. 6
ZLTC	N/A	N/A	N/A	12VDC	0-10V	N/A	Bluetooth LE Mesh	✓	✓	iOS / Android App, Wireless Wall Switch*, Autani Web Interface*	pg. 6

* Sold Separately

ZSOL option: Leviton Intellect Solo Sensor

The FFR can be equipped with an integrated Leviton Intellect Solo Sensor ("ZSOL" option). This is a 0-10V dimming Passive Infrared (PIR) occupancy and daylight harvesting sensor.

Other features:

- Partial-on
- Partial-off
- **8' to 10' mounting height**
- IP20 rated
- Detection angle: 120 degrees
- IR remote available for programming sensor from the floor (sold separately)
- Can be used to comply with IECC, ASHRAE 90.1 and 2019 Title 24, Part 6 dimming, occupancy/vacancy sensing and daylight harvesting requirements.



Keystone SmartLoop Wireless Control System

The SmartLoop wireless lighting control system by Keystone is a Bluetooth mesh lighting control system that allows you to set up and manage your lighting ecosystem quickly and easily. It's powerful enough to run a space with multiple lighting zones, but simple enough to program in minutes with your smartphone – perfect for warehouses, offices, schools, and auditoriums, whether new construction or retrofit.

- Wireless Bluetooth 2.4 GHz mesh network
- Supports up to 100 devices on a single region, with unlimited regions
- Independent per-fixture control: Occupancy, Daylight Harvesting, Task Tuning, Grouping, Scene Setting, Scheduling
- Commissioned via SmartLoop mobile app for iPhone and Android

SmartLoop Accessories

- Bluetooth Wireless Wall Switch: **KTSL-WS1-B-SG/G2**
 - Battery Powered: 2x CR2032
 - 5 Button: Power Toggle, Dimming, Automatic Sensor/Preset Level Operation, Scene Activation
- USB Time Keeper: **KTSL-TK1-USB**
 - Relays time to system components after a power loss
 - Powered by standard USB charging port
 - Internal CR1220 battery backup



- Low voltage individual fixture controller for SmartLoop system
- Integrated daylight and PIR motion sensors
- **Up to 16' mounting height.** 16' radius at 16' height.
- Works with 0-10V dim-to-off drivers with 12V aux. power



FormFocus available with Philips EasySense Sensors

EasySense MC Sensors are the ideal solution for per-luminaire control of new LED luminaires. It combines occupancy and daylight sensing in one package. The result is a cost-effective and easy-to-install solution ideal for energy savings. Commissioning and configuration during and after installation is quick and easy using the Philips MasterConnect app. This app works via Bluetooth Low Energy (BLE) technology and is available for free in the App Store and the Google Play Store.

ZESMC



- Occupancy sensing, daylight harvesting, and task tuning in one device
- **8' to 10' mounting height**
- Groups/networks up to 120 lights
- Enables auto-off/manual-on and auto-off/partial-on application
- Independent per-fixture control: Occupancy, Daylight Harvesting, Task Tuning
- Occupancy Sharing
- Scene Setting
- Advanced grouping to select Zigbee wireless wall switches
- Simple room level energy reporting with CSV file saved on the phone
- ZigBee 2.4 GHz Wireless Mesh Network
- Works with Advance Xitanium SR 120-277V drivers or other D4i certified LED drivers

Detection Area:

Longer dimension of detection area (Y1, Y2) is parallel to longer dimension of EasySense

- Minor movement (movement of a person sitting at an office desk reaching for a telephone, turning the pages in a book, opening a file folder, picking up a coffee cup, etc.)
- Major movement (movement of a person walking into or through an area.)

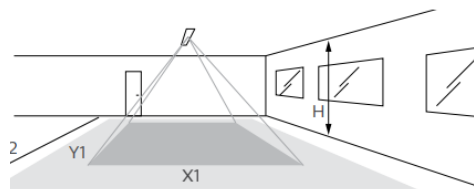

Height	Minor Movement		Major Movement	
H	X1	Y1	X2	Y2
8'	6'	10'	9'	14'
10'	8'	12'	12'	18'

Room Controllers

- Illumra **ZBT-S1AWH** (Single Rocker) or **ZBT-S2AWH** (Dual Rocker) wireless Zigbee wall switch
 - Self-Powered
 - Up to 120 sensors can be grouped to a single switch
 - Functions: On/Off, Dim-Up/Dim-Down, Scene 1, Scene 2 (Scenes: Dual Rocker Only)
 - Range: 30-100' (typical)
- Philips **SWS200** Zigbee Green Power 4-button Wall Switch
 - Battery Powered
 - Up to 120 sensors can be grouped to a single switch
 - Functions: On/Off, Dim-Up/Dim-Down, Scene 1, Scene 2
 - Range: 33' (typical)

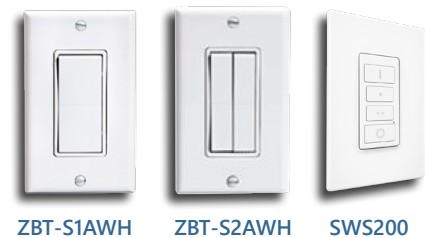

GreenMAX DRC Wireless Networked Control System with Leviton Intellect Sensors & Controllers

The GreenMAX DRC Wireless Keypad Room Controllers are used as the brain of the system, managing the fixture integrated Leviton Intellect sensors & controllers. Wirelessly commission, configure, control, monitor and provision the GreenMAX DRC system using the GreenMAX DRC App and an Android or iOS smart device.

- Occupancy/Vacancy Sensing
- Multi-Level Lighting, Partial-On, Partial-Off
- Daylight Harvesting
- Task Tuning
- Scheduling
- Grouping
- Demand Response
- BMS Integration
- ZigBee 2.4 GHz Wireless Mesh Network
- Up to 75' between devices

* DRKDN-UxW room controller required for full functionality and programming of Intellect sensors & controllers



ZLxS



- PIR Occupancy Sensor
- Daylight Sensor
- 0-10V or DALI
- **Up to 20' mounting height**

ZLxC



- Wireless fixture controller, no sensor
- 0-10V or DALI

DRKDN-UxW Room Controllers



- 1-, 2-, 4-, and 8-button configurations
- Line voltage powered: 120-277V
- Max capacity: 60 devices
- Programmable: On/Off/Raise/Lower/ Toggle/Scene
- Use any Android or iOS device for configuration using the GreenMAX DRC App



LiteTrace | Keilton+autani: Wireless networked controls, upgradeable systems

LiteTrace makes your existing building smarter by integrating the Keilton lighting controls platform with Autani's proven energy management, reporting, and control platform. Keilton+autani systems are flexible, adaptable, and resilient, providing solutions designed to scale up without having to change hardware.

Scalable product tiers allow implementing a solution aligned to your current needs, with robust upgrade pathways to expand capabilities as requirements evolve.

Capabilities	Keilton +autani (ZLTSx)	Energy Center by Autani *	Autani Insights *
Motion and Switch Groups	✓	✓	✓
Daylight Harvesting	✓	✓	✓
Schedule Lighting	✓	✓	✓
Energy Reporting & Optimization	✓	✓	✓
Overrides & Automated Demand Response	✓	✓	✓
Environment Data & Lighting Controls API		✓	✓
Building Management & System Integration		✓	✓
Building Optimization Application			✓
Location & Occupancy APIs & Beacons			✓
Future App & API Ready			✓

* additional hardware and software required.

Keilton + autani An easy and affordable stand-alone (gateway-free) room-based Bluetooth lighting control solution controllable via mobile app (iOS & Android).



EnergyCenter
BY AUTANI

A networked control solution which offers additional functionality such as advanced scheduling, reporting, metering, and building management integration.

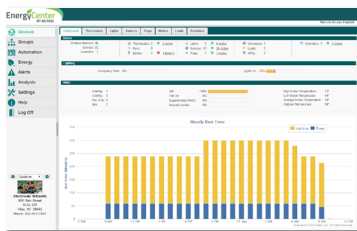

INSIGHTS
Autani

The most advanced offering, providing valuable data insights into a single building or a portfolio of buildings. This allows for asset tracking, campus-wide wayfinding, 3D facility monitoring and more.



ZLTS



- Requires a dim-to-off LED driver with 12V Aux output
- PIR + Daylight Harvesting
- IP20 Rated
- 0-10V DC dimmable
- Bluetooth-enabled
- **Up to 18' mounting height.** 16' radius at 15' height.

ZLTC



- Wireless 0-10V fixture controller
- Integral Bluetooth module
- 12VDC Input

Room Controllers



WP1013 WP1025 WP1018 WP1018A

Battery Powered

- 3-, 5-, and 8-button configurations
- Bluetooth Enabled
- 1 x CR2032 battery (WP1013, WP1025, WP1018)
- 2 x AAA batteries (WP1018A)
- Approx. 3 year battery life (batteries not included)



WP1013S WP1017S IWS102

Line Voltage

- 3-, 7-button configurations, and Occ/Vac Sensor Switch
- Line voltage powered: 120-277V
- Bluetooth Enabled



Installation Instructions:



1) Turn off power to luminaire, remove all fluorescent components, dispose of properly.



2) Insert endcaps between ceiling grid and troffer.



3) Slide LED panel between grid and troffer, fasten with provided quarter turns.



4) Connect LED panel with provided disconnect. Insert blank side panel between grid and troffer, fasten with provided quarter turns.



5) Insert lens material into track, turn on power.



Total Install time: less than 5 minutes!



Installation Demo Online:

An online demonstration video can be found on our YouTube channel [at this link](#).

