

Project: _____
 Location: _____
 Cat. #: _____
 Type: _____
 Quantity: _____

LED

NVL G2 2 | LED Vaportight

Features:

- High performance LED technology
- 90+ CRI standard
- 0-10V dimming drivers standard
- DALI drivers available
- Field replaceable LED boards & drivers
- Multiple hanging options, including surface, chain, and aircraft cable, for easy installation
- Durable materials and craftsmanship allows the NVL to withstand some of the harshest environments

Applications:

Most industrial, retail, and recreational low bay and high bay applications

- Warehouse/Manufacturing Facility
- Food Processing
- Gymnasium
- Car Wash
- Cold/Frozen Storage (*cold temperature rules apply. Refer to warranty document at www.lumenfocus.com/support for details*)

Predicted Lifetime:

- L70 ≥ 129,000 hrs (calculated)
- L80 ≥ 81,000 hrs (calculated)
- L90 ≥ 39,000 hrs (reported)
- 85% lumen maintenance @ 60,000 hrs (*based on LM-80, TM-21 and in-situ laboratory testing*)

Ambient Operating Temp.:

- -30°C to 30°C for SH output
- -30°C to 35°C for VH output
- -30°C to 40°C for VL, LW, MD, HI output

Construction:

- UL 5VA fiberglass housing (will not melt or burn)
- Impact resistant acrylic and UV stabilized polycarbonate lenses
- Pre-painted cold rolled steel board trays
- Acetal copolymer secure locking plastic latches (stainless steel latches optional)
- Stainless steel mounting hardware

Certifications:

- UL 1598 listed for US and Canada, suitable for wet locations
- DesignLights Consortium qualified on specific configurations (refer to DLC qualified products list for exact model numbers) <http://designlights.org/>
- IP65
- IP66
- IP67
- NEMA 4X
- NSF
- PSI 1500
- RoHS



Ordering Guide:

example: NVL G2 2 HI UV FSA 940 SMBBQC

Series	Length	Output	Voltage	Shielding	CRI/CCT	Hanging	Controls	Options
NVL G2	2							
NVL G2 NVL Gen 2	2 2'	VL Very Low	UV 120-277	CRP Clear Ribbed Polycarbonate	930 90 CRI/3000K	Blank Surface Mounting Bracket (Comes Standard)	Blank No Controls	Blank No Options
		LW Low	34 347V	FRP Frosted Ribbed Polycarbonate	935 90 CRI/3500K	SMBB Mounting Bracket Bail (For Chain or Cable Mounting)	ZOS Occupancy Sensor (On/Off) ⁽¹⁾	C6 6' Single Circuit Cord
		MD Medium		CSP Clear Shallow Polycarbonate	940 90 CRI/4000K	SMBBQC Bracket Bail with 10' Quick Hang Cable Kit	ZOSMD Microwave Photo/Motion Sensor With Step-Dimming (High/Low/Off) ⁽¹⁾	C6(LVL) C6 With Integrated Dimming Leads
		HI High		FSP Frosted Shallow Polycarbonate	950 90 CRI/5000K	SMBBQC20 Bracket Bail with 20' Quick Hang Cable Kit	ZOFD1 Leviton Bluetooth-enabled Programmable Dimming/Occupancy/Daylight Harvesting Sensor with Grouping (120-277V) ⁽¹⁾	C10 10' Single Circuit Cord
		VH Very High		CRA Clear Ribbed Acrylic		SM45 45° Surface Mount Bracket	ZOFD1 Leviton Bluetooth-enabled Programmable Dimming/Occupancy/Daylight Harvesting Sensor with Grouping (120-277V) ⁽¹⁾	C10(LVL) C10 With Integrated Dimming Leads
		SH Super High		FRA Frosted Ribbed Acrylic			ZOFDU Leviton Bluetooth-enabled Programmable Dimming/Occupancy/Daylight Harvesting Sensor with Grouping, Scheduling (120-480V) ⁽¹⁾	D6 6' Dual Circuit Cord
				CSA Clear Shallow Acrylic			ZOFDU Leviton Bluetooth-enabled Programmable Dimming/Occupancy/Daylight Harvesting Sensor with Grouping, Scheduling (120-480V) ⁽¹⁾	D10 10' Dual Circuit Cord
				FSA Frosted Shallow Acrylic			Z221BL Wattstopper Programmable Photo/Motion Multi-Voltage Sensor (high/low/off) ⁽²⁾	P(NEMA) Plug (Specify NEMA configuration)
				CDA Clear Deep Acrylic			Z321BL Wattstopper Bluetooth-enabled Programmable Dimming/Occupancy/Daylight Harvesting Multi-Voltage Sensor ⁽²⁾	EM1 Emergency Pack - Up To 8W ⁽⁶⁾
				FDA Frosted Deep Acrylic				EM1C Emergency Pack - Up To 14W ⁽⁷⁾

Notes

- ⁽¹⁾ Max mounting height 40'. See Page 4 for more details
- ⁽²⁾ " " = lens type. Max mounting height 40'. See Page 4 for more details.
- ⁽³⁾ See Page 5 for more details.
- ⁽⁴⁾ Max mounting height 40'. See Page 5 for more details on advanced controls.
- ⁽⁵⁾ Max mounting height 50'. See Page 5 for more details on advanced controls.
- ⁽⁶⁾ EM1 - 120-277V / 10°C-50°C ambient.
- ⁽⁷⁾ EM1C - 120-277V / -20°C-50°C ambient. Adds 30W to system wattage.
- ⁽⁸⁾ EM2 - 120-277V / 0°C-50°C ambient.

Controls Accessories (order separately)

For Douglas Controls

- BT-DMSW-U-A Bluetooth 1 Zone Dimmer
- BT-4BTSW-U-A Bluetooth 4-Button Wall Station
- BT-8BTSW-U-A Bluetooth 8-Button Wall Station

For Enlighted Controls

- WS-2-00 Enlighted Remote Control Wall Switch (for Enlighted Connected & IoT)
- WS-2-00-IL Enlighted Remote Control Wall Switch (for Enlighted One)

For WattStopper Controls

- FSIR-100 Wireless IR Programming Tool (For Z221Lx)

- ZPC**
Photocell
- ZIFC**
Douglas IFC Controller With Network Capabilities⁽³⁾
- ZFMS**
Douglas FMS Sensor with Dimming/Occupancy/Daylight Harvesting with Network Capabilities ⁽⁴⁾
- ZENLO**
Enlighted Ruggedized Sensor with Dimming/Occupancy/Daylight Harvesting and Enlighted One System ⁽⁵⁾
- ZENLC**
Enlighted Ruggedized Sensor with Dimming/Occupancy/Daylight Harvesting and Enlighted Connected System ⁽⁵⁾
- ZENLI**
Enlighted Ruggedized Sensor with Dimming/Occupancy/Daylight Harvesting and Enlighted IoT System ⁽⁵⁾
- SSL**
Stainless Steel Latches
- SC**
Safety Cable
- F**
Fuse
- SDT(480V)**
480V To 277V Step Down Transformer
- LVL**
0-10V Dimming Leads for Easy Field Access
- BAA**
Buy American Act Compliant



Performance Chart:

Catalog #	Watts	Lumens (930)	LPW (930)	Lumens (935)	LPW (935)	Lumens (940)	LPW (940)	Lumens (950)	LPW (950)
NVL G2 2 VL UV FRA 9xx	9.2	1123.0	122.1	1127.8	122.6	1154.6	125.5	1154.6	125.5
NVL G2 2 LW UV FRA 9xx	15.2	2135.1	140.6	2144.1	141.2	2195.1	144.5	2195.1	144.5
NVL G2 2 MD UV FRA 9xx	23.9	3123.5	130.6	3136.6	131.1	3211.1	134.2	3211.1	134.2
NVL G2 2 HI UV FRA 9xx	30.5	4111.4	134.9	4128.7	135.4	4226.8	138.7	4226.8	138.7
NVL G2 2 VH UV FRA 9xx	36.7	5089.7	138.7	5111.1	139.3	5232.5	142.6	5232.5	142.6
NVL G2 2 SH UV FRA 9xx	45.3	6058.5	133.9	6084.0	134.4	6228.6	137.6	6228.6	137.6

Lumen Adjustment Factors:

FDA: 1.045 FSA: 1.039 CDA: 1.053 CRA: 1.051 CSA: 1.058

Photometric Data:

Relative Luminous Intensity with FRA lens

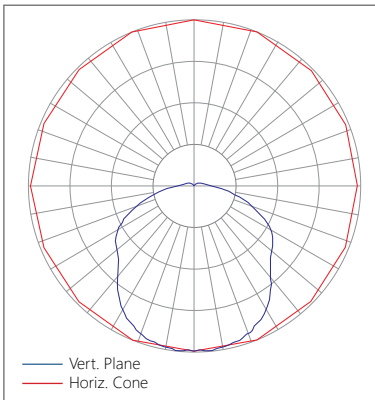

Relative Luminous Intensity with FDA lens

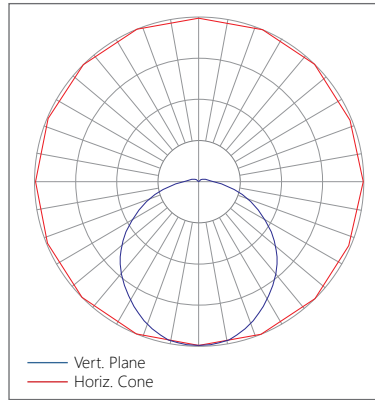

Relative Luminous Intensity with FSA lens

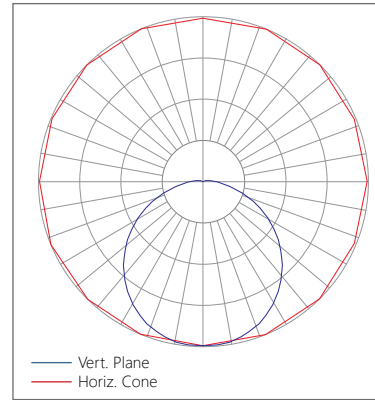

Schematic:

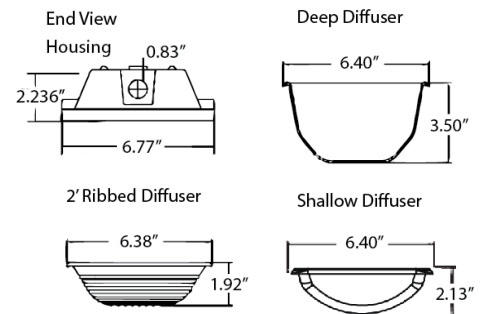
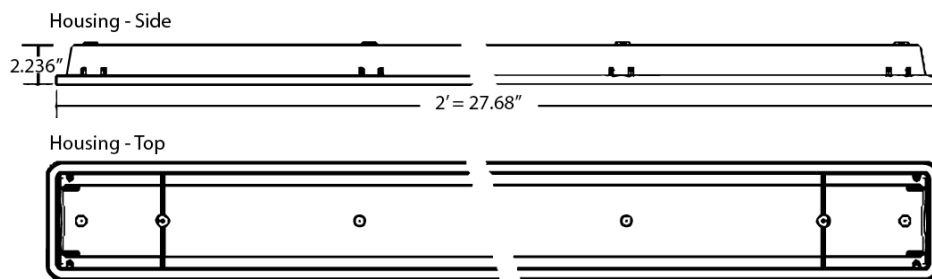

The NVL features field replaceable boards and drivers. This allows you to upgrade to more efficient technology in the future. Or, in the rare event of a failure, you can rapidly replace defective components. Re-boardABILITY helps to ensure you won't get stuck with an obsolete light fixture. [Learn more about Re-boardABILITY here.](#)



Controls Summary:

Control Code	Type	Capabilities	Communication
ZOS	Motion (PIR)	On/Off	Wired
ZOSMD	Motion (Microwave), Photosensor	On/Low/Off	Wired 1-10V
ZOFD1	Motion (PIR), Daylight Harvesting	High/Low/Off, High-End Trim, Grouping	Wired 0-10V, Programmable via Bluetooth App (iOS, Android)
ZOFDU	Motion (PIR), Daylight Harvesting	High/Low/Off, High-End Trim, Grouping, Scheduling	Wired 0-10V, Programmable via Bluetooth App (iOS, Android)
Z221BLx	Motion (PIR), Photosensor	High/Low/Off, High-End Trim	Wired 0-10V, Programmable via IR remote (sold separately)
Z321BLx	Motion (PIR), Daylight Harvesting	High/Low/Off, High-End Trim	Wired 0-10V, Programmable via Bluetooth App (iOS, Android)
ZPC	Photosensor	On/Off	Wired
ZIFC	Controller, No Sensors	High/Low/Off, High-End Trim, Grouping, LLLC (Douglas Lighting Controls-Dialog)*	Wireless Bluetooth Mesh, Programmable via iOS App or Douglas Dialog Software
ZFMS	Motion (PIR), Daylight Harvesting	High/Low/Off, High-End Trim, Grouping, LLLC (Douglas Lighting Controls-Dialog)*	Wireless Bluetooth Mesh, Programmable via iOS App or Douglas Dialog Software
ZENLO	Motion (PIR), Daylight Harvesting	High/Low/Off, High-End Trim, Grouping, Upgradable to Connected (ZENLC) or IoT (ZENLI)	Wireless Bluetooth Low Energy Mesh, Programmable via Enlighted Room Controller WS-2-00-IL (sold separately)
ZENLC	Motion (PIR), Daylight Harvesting	High/Low/Off, High-End Trim, Grouping, Scheduling*, Energy Monitoring*, BMS Integration*, LLLC (Enlighted IoT)*, Upgradable to IoT (ZENLI), LLLC (Enlighted IoT)*	Wireless Bluetooth Low Energy Mesh, Programmable via Enlighted IoT Software
ZENLI	Motion (PIR), Daylight Harvesting	High/Low/Off, High-End Trim, Grouping, Scheduling*, Energy Monitoring*, BMS Integration*, LLLC (Enlighted IoT)*, Space - Building Utilization*, Where - Real Time Location Services*	Wireless Bluetooth Low Energy Mesh, Programmable via Enlighted IoT Software

LLLC = Luminaire Level Lighting Control
 * Additional equipment required. Contact LumenFocus representative for details

On/Off Occupancy Sensor (ZOS)

The Leviton OSFHL-CTW (or equivalent) is an end mounted PIR On/Off motion sensor. It comes with two interchangeable lenses: Low Bay (8-25' heights), High Bay (20-40' heights), as well as an aisle mask.

- IP65 rated



Microwave Occupancy Sensor (ZOSMD)

The Leviton OSM3D-DDW (or equivalent) detects motion through low density materials using high frequency electromagnetic waves. This means it can sit discretely behind the NVL's lens. The high frequency waves offer less interference and false tripping than traditional sensing technology for reliable occupancy applications. The ZOSMD features automatic switching or dimming based on motion. The ZOSMD option adds step-dimming functionality - standby dimming level 10% / 20% / 30% / 50%. Max mounting height is 40 feet.



Programmable Dimming Sensors:

ZOFDx Sensors



The ZOFDx option includes four sensor lenses that can easily be installed or swapped out in the field. From left: the high bay lens (20'-40' mounting), the high bay lens with aisleway mask, the low bay lens (8'-20' mounting), and the low bay lens with aisleway mask.

- Leviton Smart IP66 passive infrared (PIR) sensors
- Features mesh grouping (16 devices per group), occupancy sensing, daylight harvesting, scheduling (for ZOSFDU only), single-level switching
- Comes pre-installed on the end cap
- Rated for cold locations
- Configurable through the Leviton Smart Sensor App using a smartphone or other Bluetooth-enabled iOS or Android device

Z221B/Z321B Sensors

- The Wattstopper FSP sensor provides multi-level control based on motion and/or daylight contribution
- Rated for cold locations
- Parameters for Bluetooth-enabled Z321B adjustable via phone app - iOS or Android
- Parameters for Z221B adjustable via wireless configuration tool (FSIR-100 - sold separately)
- Three lenses available, tailored for the ideal detection area and mounting height:
 - L2: 360° lens, maximum coverage 48', diameter from 8' height
 - L3: 360° lens, maximum coverage 40', diameter from 20' height
 - L7: 360° lens, maximum coverage 100', diameter from 40' height



1) The Wattstopper FSP sensor. 2) The phone app interface for the Z321B. 3) The FSIR-100 wireless configuration tool.



Universal Douglas: Cloud-based controls FMS High bay sensor

The NVL can be equipped with the Douglas FMS sensor, which is designed for high bay applications.

With a max sensor height up to 40 feet, the FMS is ideal for applications like warehouses and manufacturing facilities. It can be installed for on/off control or bi-level light functionality. The daylight sensor provides additional savings by dimming the lights to work with the amount of natural available daylight.

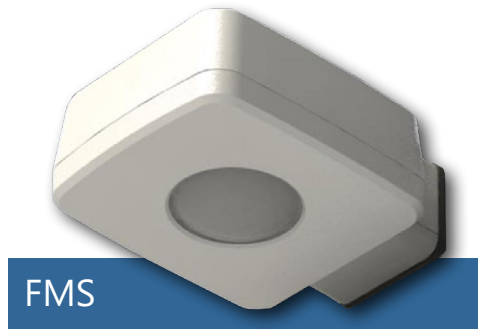

- Configuration from the floor via smartphone app
- Bluetooth mesh network is created between devices for control over a group of Douglas sensors
- Occupancy and daylight sensing
- IP65-rated
- 0-10V dimming
- 150 feet clear line of site, 50 feet through standard walls (distances may vary based on location and environment)

CheckLight® Energy Management System

Douglas controls can be integrated with the CheckLight® Energy Management system. This system can help you uncover energy conversion opportunities, create conservation strategies, analyze lighting load inefficiencies, and make configuration changes from anywhere with Douglas' user-friendly interface. You can get measurements, reports, and control your system from a web-based application.

- CheckLight® has the capability to look at different facilities within a portfolio and use data benchmarks to compare building performances.
- Find energy conservation opportunities
 - Create energy saving strategies
 - Analyze load inefficiencies
 - Optimize energy management

Intelligent Fixture Controller (IFC)

The NVL can be equipped with the Douglas Bluetooth Intelligent Fixture Controller (IFC).

- 0-10V dimming with dim-to-off
- Bluetooth beacon for digital ceiling, IoT and location service strategies
- 150-foot clear line of sight, 50 feet through standard walls
- May be used with dual-channel, tunable white LED drivers providing auxiliary power and dim-to-off capability
- Commissioning through Douglas Lighting Controls, Inc. app from Apple app store
- Listed for emergency control when used on dedicated emergency power bus

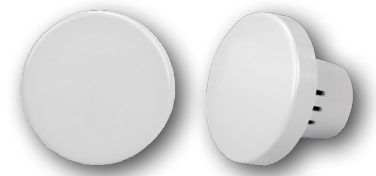

Enlighted: All-in-one sensors, upgradeable systems

Enlighted's IP65-rated Ruggedized Sensor is an all-in-one unit: task tuning, high-end trimming, daylight harvesting, and occupancy/vacancy detection. Max installation height is 50 feet.

Enlighted sensors come standard with the Enlighted One system (the "ZENLO" option). Enlighted Connected ("ZENLC") offers even more options. The Enlighted IoT ("ZENLI") option allows the full implementation of Enlighted's services. Each system can be fully upgraded to the next tier in the future. So if you start with Enlighted One but want to add energy reporting or building management systems integration in the future, you can.



Enlighted Capabilities*	Enlighted One (ZENLO)	Enlighted Connected (ZENLC)	Enlighted IoT (ZENLI)
Motion and Switch Groups	✓	✓	✓
Daylight Harvesting	✓	✓	✓
Schedule Lighting		✓	✓
Energy Reporting & Optimization		✓	✓
Environment Data & Lighting Controls API		✓	✓
Building Management System Integration		✓	✓
Where & Space Applications			✓
Location & Occupancy APIs & Beacons			✓
Future App & API Ready			✓

Note: Additional equipment required for ZENLC and ZENLI

Real-time data analytics

Enlighted's control units compile data in real-time, which can be viewed via the Energy Manager. The Energy Manager is part of the Enlighted Connected and Enlighted IoT configurations.

- Real-time measurements and verification of energy savings
- Space analytics - data can be compiled into motion trails and heat maps
- Analyze traffic density and congestion in a space

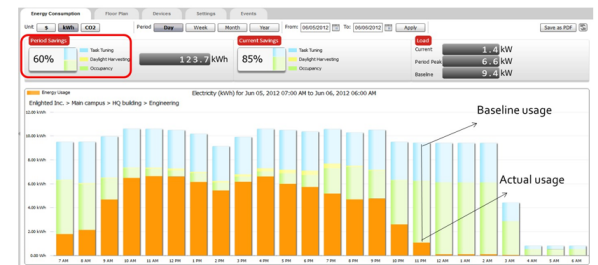

Learn more about our available advanced controls options here:

www.lumenfocus.com/controls-overview

© 2021 Enlighted for all Enlighted content and images.

© 2021 Douglas Lighting Controls, Inc. for all Douglas content and images. The Bluetooth® word, mark and logos are registered trademarks owned by the Bluetooth SIG, Inc. and any use of such marks by Douglas Lighting Controls is under license. Other trademarks and trade names are those of their respective owners.



Mounting:

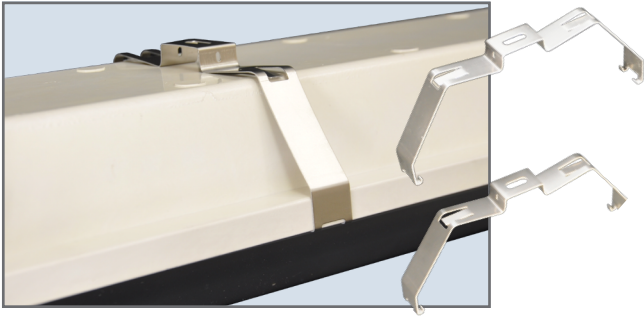

SM Surface Mount Bracket (comes standard)

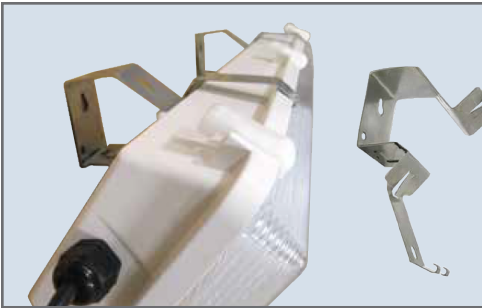

SM45 45° Surface Mount Bracket

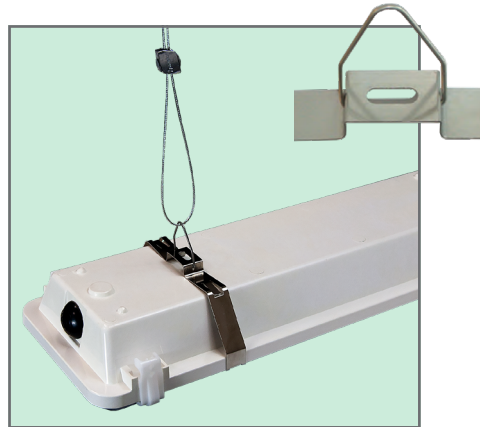

SMBB Surface Mount with Bracket Bail - for chain or cable mounting. (Shown with QC)

